

# SMD 2835 0.5 W Data Sheet

---

---

---



## India's first LED Chip – Complying International Quality and Lighting Standards.

### **Description:**

Indo Japan's SMD LED 2835 series products use high quality silica gel packages, which improves the heat dissipation, thus enhancing the performance and reliability of LED Chips.

SMD LED 2835 series has low power consumption, high CRI, wide beam angle, long product life, which makes this series suitable for all forms of lighting applications.

### **Features:**

- LM80 Compliant
- RoHS & CE Compliant
- Pb free
- Size : 2.8mm x 3.5mm x 0.65mm
- Viewing Angle : 120°
- White LED 2835
- High Lumen Output
- Low Power Consumption

### **Applications:**

- General Lighting
- Automotive Lighting
- Decorative Lighting
- Indicator Lighting
- Switch Lighting

# SMD 2835 0.5 W Data Sheet



## Absolute Maximum Ratings ( $T_{\text{Soldering}} / T_a = 25^{\circ}\text{C}$ )

Parameters	Symbol	Rating	Unit
Forward Current	$I_f$	200	mA
Peak Forward Current (Duty 1/10 @10ms)	$I_{fp}$	300	mA
Power Dissipation	$P_d$	680	mW
Operating Temperature	$T_{opr}$	-40 ~ +85	$^{\circ}\text{C}$
Storage Temperature	$T_{stg}$	-40 ~ +100	$^{\circ}\text{C}$
Thermal Resistance (Junction / Soldering point)	$R_{th J-S}$	15	$^{\circ}\text{C}/\text{W}$
Junction Temperature	$T_j$	115	$^{\circ}\text{C}$
Soldering Temperature	$T_{sol}$	Reflow Soldering : 260 $^{\circ}\text{C}$ for 10 sec. Hand Soldering : 350 $^{\circ}\text{C}$ for 3 sec.	

Note:

1. The products are sensitive to static electricity and must be carefully taken when handling products.

Parameter	Symbol	Min.	Typ.	Max.	Unit	Condition
Luminous Flux(1)	$\Phi$	40	----	75	lm	$I_f = 150\text{mA}$
Forward Voltage(2)	$V_F$	2.8	----	3.4	V	$I_f = 150\text{mA}$
Color Rendering Index(3)	$R_a$	80	----	90		$I_f = 150\text{mA}$
Viewing Angle	201/2	----	120	----	deg	$I_f = 150\text{mA}$
Reverse Current	$I_R$	----	----	10	$\mu\text{A}$	$V_r = 5\text{V}$

# SMD 2835 0.5 W Data Sheet



Luminous Flux	Bin Code
60 – 65 lm	K1
65 – 70 lm	K2

Voltage	Bin Code
3.2 – 3.4V	V2

Notes:

1. Tolerance of Luminous flux:  $\pm 3\%$ .
2. Tolerance of Forward Voltage:  $\pm 0.1V$ .
3. Tolerance of Colour Rendering Index:  $\pm 2$

Bin Code	Lumens	Voltage	CCT
K1V2A1	60 – 65 lm	3.2 – 3.4V	2700 – 3000K
K1V2A2	60 – 65 lm	3.2 – 3.4V	3000 – 3300K
K1V2B1	60 – 65 lm	3.2 – 3.4V	3900 – 4200K
K1V2B2	60 – 65 lm	3.2 – 3.4V	4200 – 4500K
K1V2C1	60 – 65 lm	3.2 – 3.4V	5800 – 6200K
K1V2C2	60 – 65 lm	3.2 – 3.4V	6200 – 6600K
K1V2C3	60 – 65 lm	3.2 – 3.4V	6600 – 7000K
K2V2A1	65 – 70 lm	3.2 – 3.4V	2700 – 3000K
K2V2A2	65 – 70 lm	3.2 – 3.4V	3000 – 3300K
K2V2B1	65 – 70 lm	3.2 – 3.4V	3900 – 4200K
K2V2B2	65 – 70 lm	3.2 – 3.4V	4200 – 4500K
K2V2C1	65 – 70 lm	3.2 – 3.4V	5800 – 6200K
K2V2C2	65 – 70 lm	3.2 – 3.4V	6200 – 6600K
K2V2C3	65 – 70 lm	3.2 – 3.4V	6600 – 7000K

# SMD 2835 0.5 W Data Sheet



## Relative Luminous Intensity vs Junction Temperature

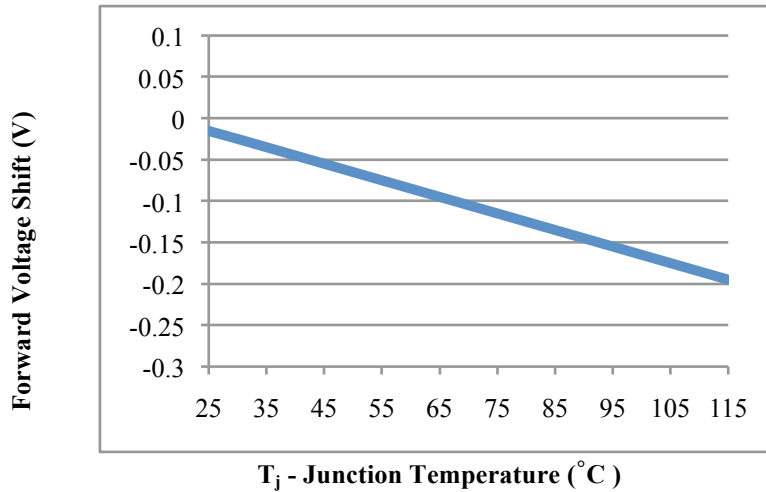

## Forward Current vs Relative Luminous Intensity

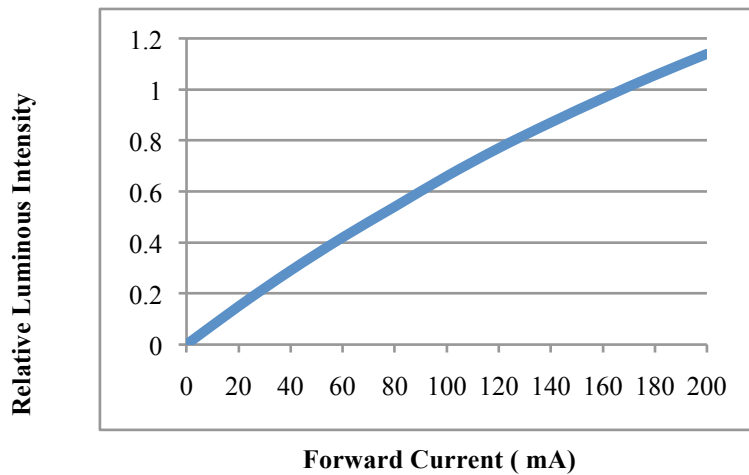

# SMD 2835 0.5 W Data Sheet



## Relative Luminous Intensity vs Junction Temperature

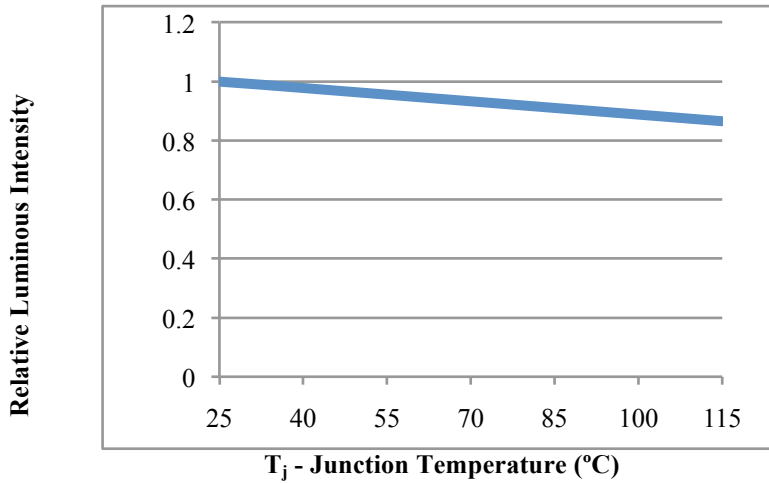

## Forward Current vs. Forward Voltage

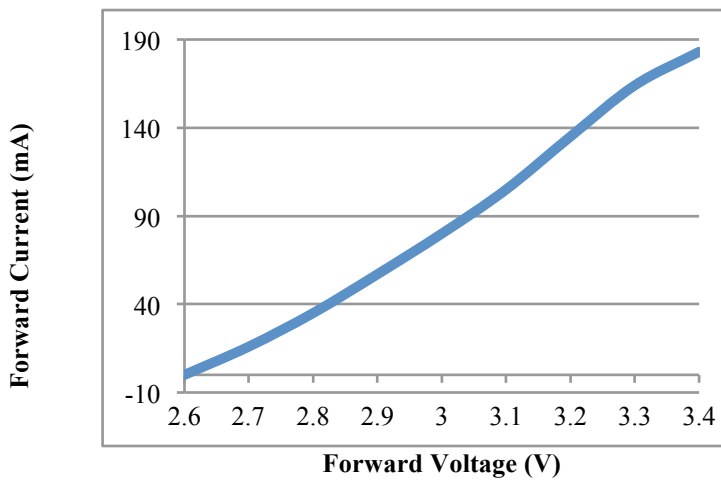

# SMD 2835 0.5 W Data Sheet



## Max Driving Forward Current vs Soldering Temperature

$R_{th\ j-S=21}$  °C/W

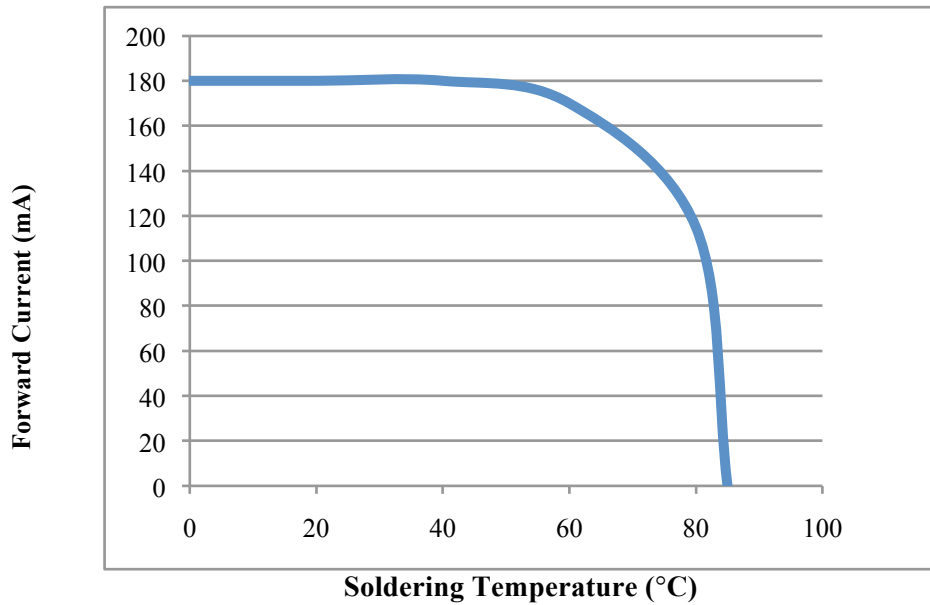

## Spectrum Distribution

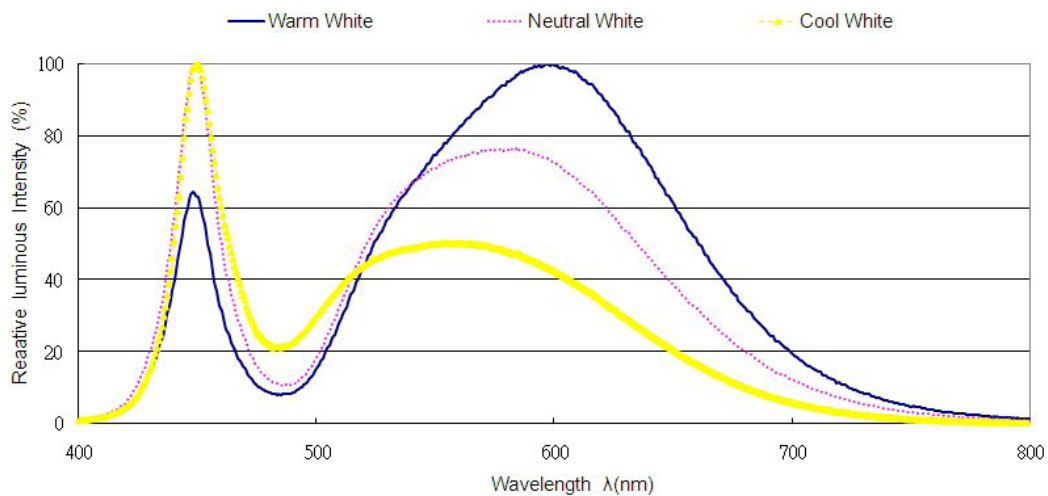

# SMD 2835 0.5 W Data Sheet



## CCT – BIN FOR WARM WHITE LIGHT

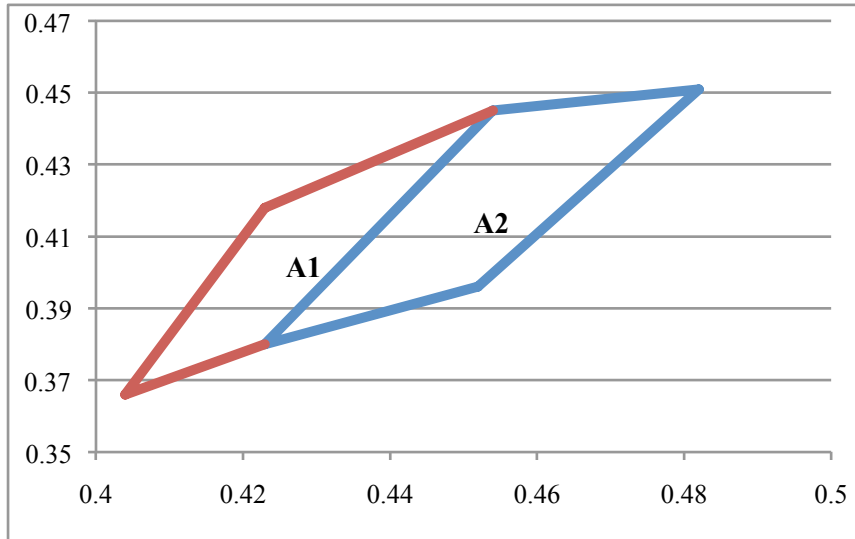

<b>BIN A 1</b>	<b>2700 – 3000K</b>
<b>BIN A 2</b>	<b>3000 – 3300K</b>

## CCT – BIN FOR NATURAL WHITE

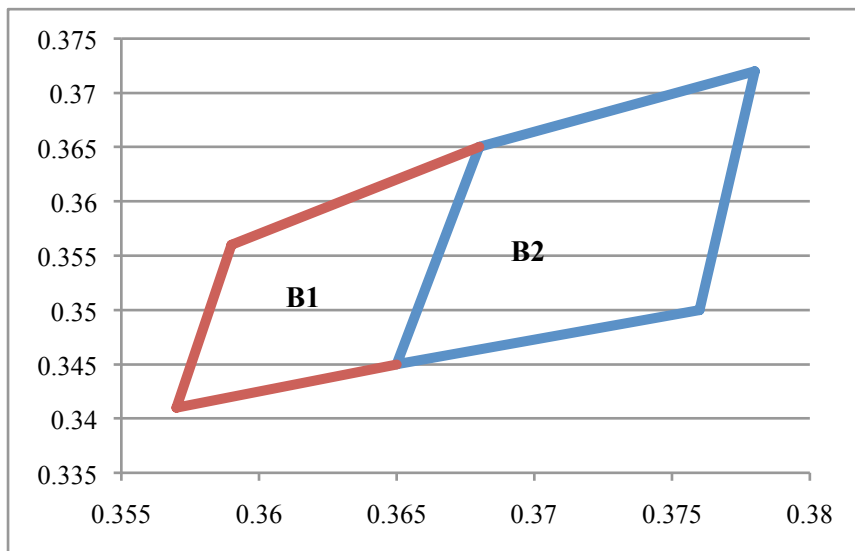

<b>BIN B 1</b>	<b>3900 – 4200K</b>
<b>BIN B 2</b>	<b>4200 – 4500K</b>

# SMD 2835 0.5 W Data Sheet



## CCT – BIN FOR COOL WHITE

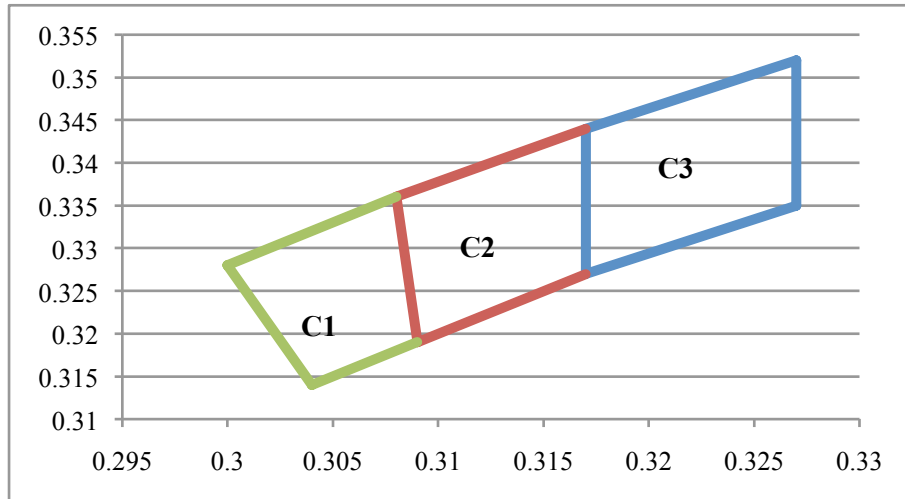

<b>BIN C 1</b>	<b>5800 – 6200K</b>
<b>BIN C 2</b>	<b>6200 – 6600K</b>
<b>BIN C 3</b>	<b>6600 – 7000K</b>



# SMD 2835 0.5 W Data Sheet



## Package Dimension

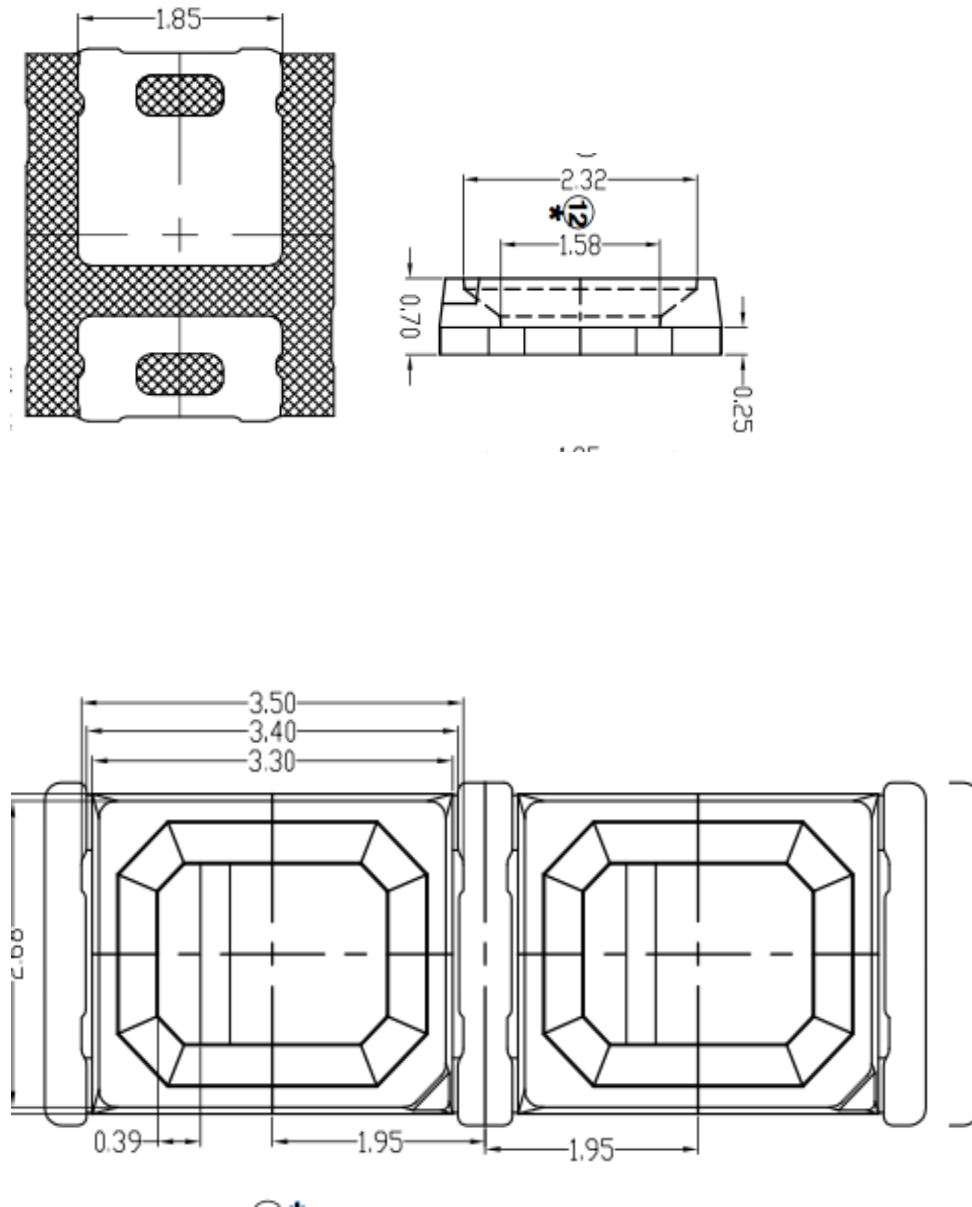

Note:

Tolerance unless mentioned is  $\pm 0.15$  mm; Unit = mm

# SMD 2835 0.5 W Data Sheet



## Reel Dimensions

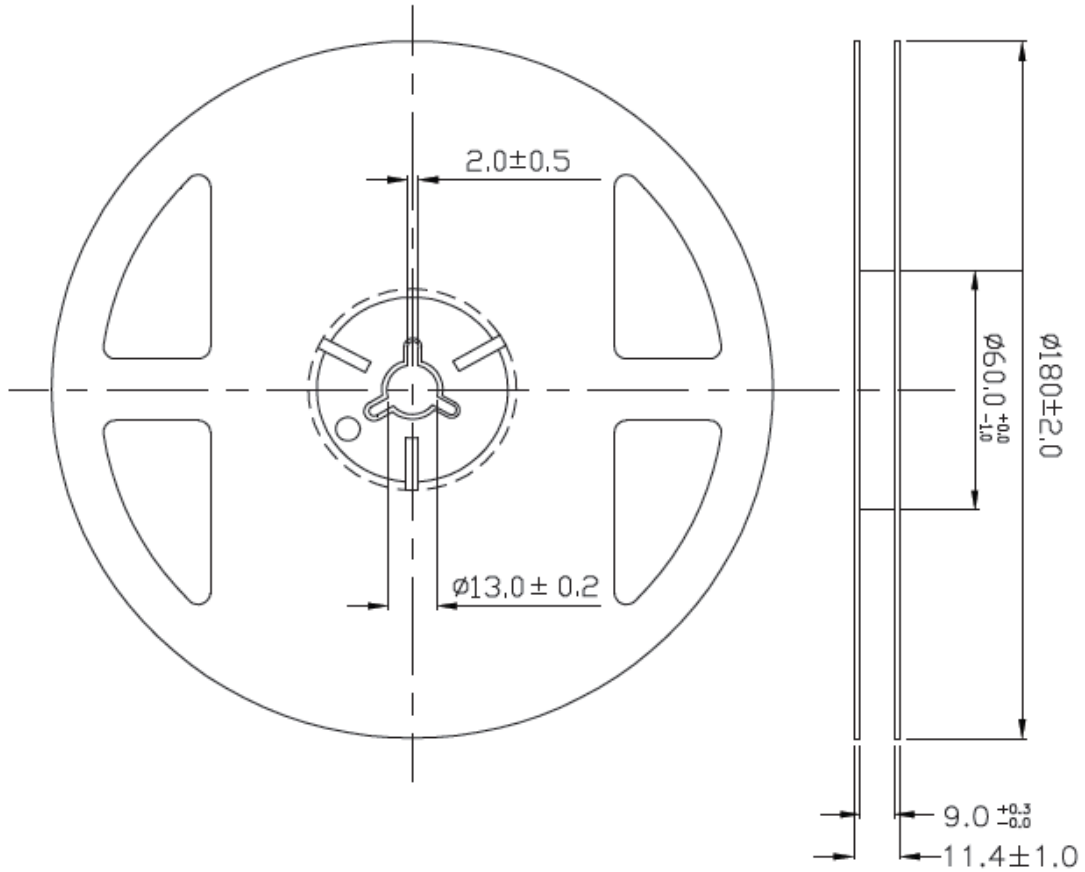

Note:

Tolerances unless mentioned  $\pm 0.1$  mm. Unit = mm

# SMD 2835 0.5 W Data Sheet



## Moisture Resistant Packing Process

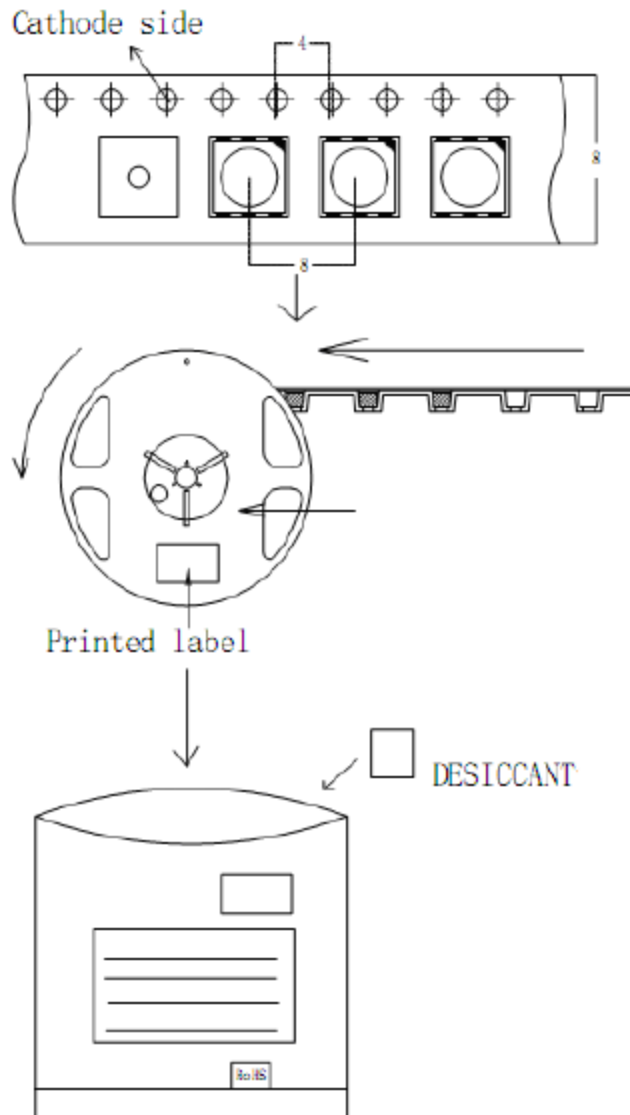

# SMD 2835 0.5 W Data Sheet

---

---

---



## Notes for Reflow Soldering

- Reflow soldering should not be done more than twice.
- To ensure the reliability, quality and high performance the LED's have been encapsulated with silica gel. It not recommended to put any kind of pressure on the Chip.
- Use of high precision nozzles to avoid any sort of damage to Chips is recommended
- Use of anti-static apparels while operating on LED Chips is recommended
- Ensure high quality earthing/ground wiring.

## Notes for Hand Soldering

- Hand Soldering Parameters - 300°C for not more than 3 seconds
- Hand Soldering shouldn't be done more than once.
- Avoid using sharp objects for compressing LEDs
- Use of anti-static apparels while operating on LED Chips is recommended

## Storage

### Before opening vacuum packing

- LEDs can be stored for one year under temperature and humidity not exceeding 30°C and 60% RH.

### After opening vacuum packing

- The LED's floor life is 168 Hrs under 30°C or less and 60% RH or less. Unused LEDs should be stored in moisture proof packages.