

IJFCOB19A Data Sheet



India's first LED Chip – Complying International Quality and Lighting Standards.

Description:

Indo Japan's F - COB series products use high quality silica gel packages with Aluminium Oxide Substrate which improves the heat dissipation, thus enhancing the performance and reliability of LED Chips.

F - COB series has low power consumption, high CRI, wide beam angle, long product life and less heat emission compared to traditional COBs which makes this series suitable for all forms of lighting applications.

Features:

- RoHS & CE Compliant
- Pb free
- Size : 19mm x 19mm x 1.6mm
- Viewing Angle : 120°
- COB LED
- High Lumen Output
- Low Power Consumption

Applications:

- Spot Light
- Down Light
- Façade Light
- Street Light
- Flood Light
- Automobile Headlamp

IJFCOB19A Data Sheet



Absolute Maximum Ratings ($T_{\text{Soldering}} / T_a = 25^{\circ}\text{C}$)

Parameters	Symbol	Rating	Unit
Max Forward Current	I_f	350	mA
Peak Forward Current (Duty 1/10 @10ms)	I_{fp}	420	mA
Max. Power Dissipation	P_d	13860	mW
Operating Temperature	T_{opr}	-40 ~ +85	$^{\circ}\text{C}$
Storage Temperature	T_{stg}	-40 ~ +100	$^{\circ}\text{C}$
Thermal Resistance (Junction / Soldering point)	$R_{th J-S}$	10	$^{\circ}\text{C}/\text{W}$
Junction Temperature	T_j	135	$^{\circ}\text{C}$
Soldering Temperature	T_{sol}	Reflow Soldering : 260 $^{\circ}\text{C}$ for 10 sec. Hand Soldering : 350 $^{\circ}\text{C}$ for 3 sec.	

Note:

1. The products are sensitive to static electricity and must be carefully taken when handling products.

IJFCOB19A Data Sheet



Parameter	Symbol	Min.	Typ.	Max.	Unit	Condition
Luminous Flux	Φ		1404		lm	$I_f = 350\text{mA}$
Forward Voltage	V_F	37.6		39.6	V	$I_f = 350\text{mA}$
CRI	Ra	70	80	90		$I_f = 350\text{mA}$
Viewing Angle	2 θ 1/2	----	140	----	deg	$I_f = 350\text{mA}$
Reverse Current	I_R	----	----	50	μA	$V_r = 5\text{V}$

Notes:

1. Tolerance of Luminous flux: $\pm 11\%$.
2. Tolerance of Forward Voltage: $\pm 0.1\text{V}$.
3. Tolerance of Colour Rendering Index: ± 2

Spectrum Distribution

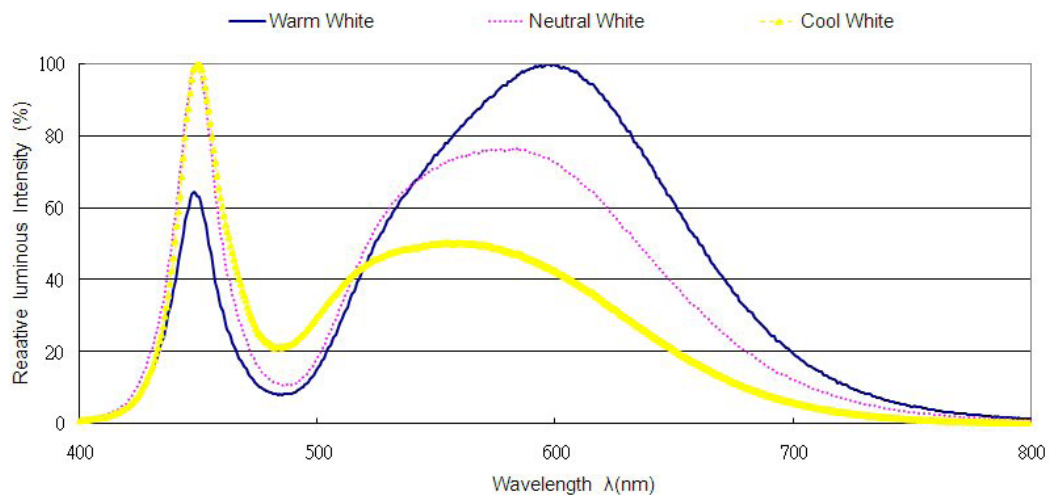

IJFCOB19A Data Sheet



Forward Voltage Shift vs Junction Temperature

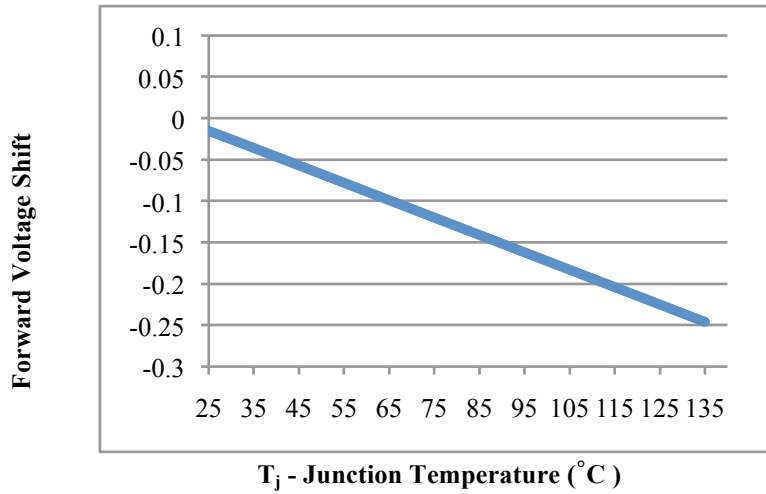

Relative Luminous Intensity vs Forward Current

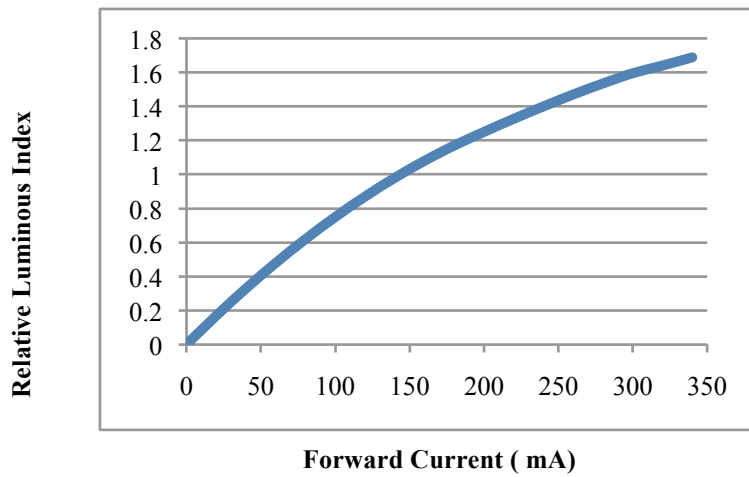

IJFCOB19A Data Sheet



Relative Luminous Intensity vs Junction Temperature

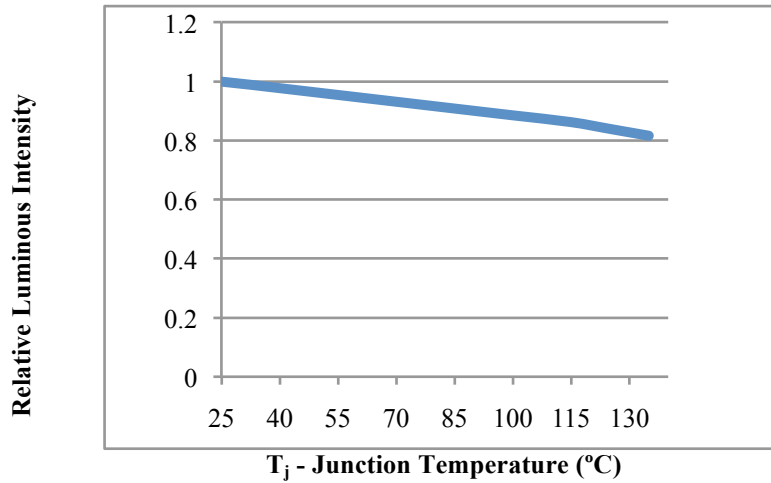

Forward Current vs. Forward Voltage

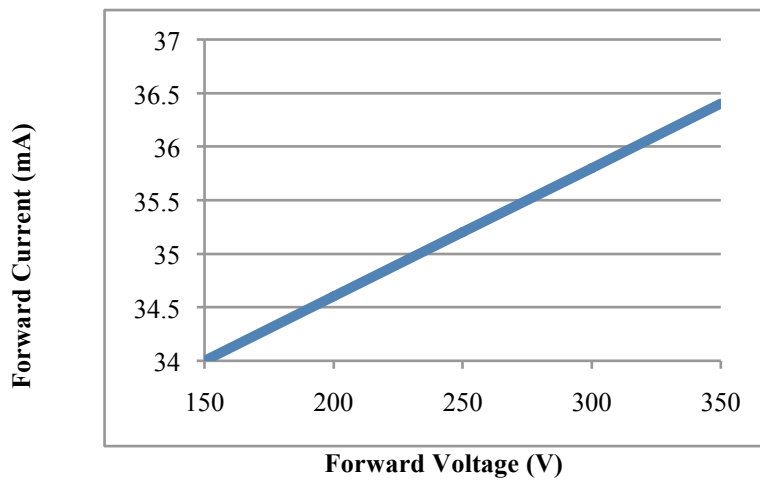

IJFCOB19A Data Sheet



Max Driving Forward Current vs Soldering Temperature

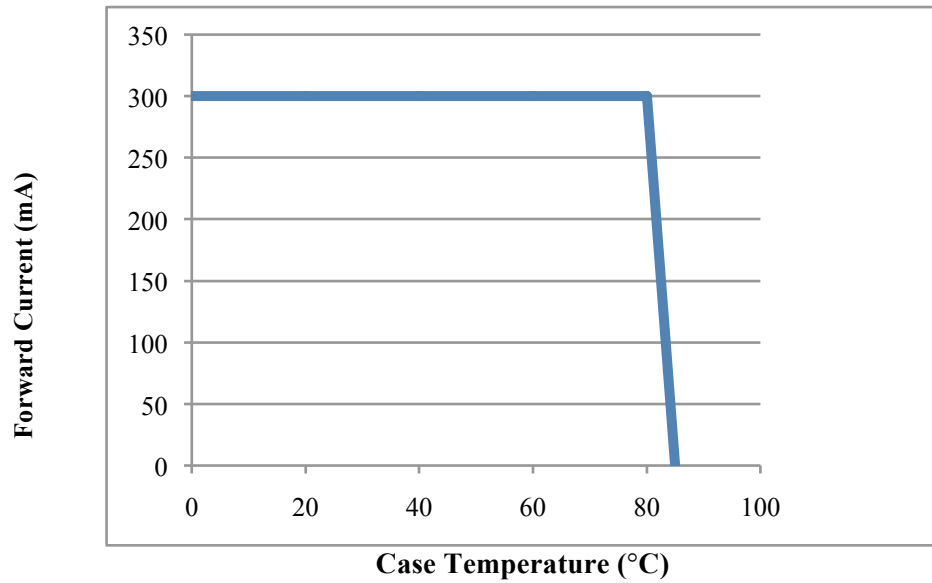

Max Driving Forward Current vs Ambient Temperature

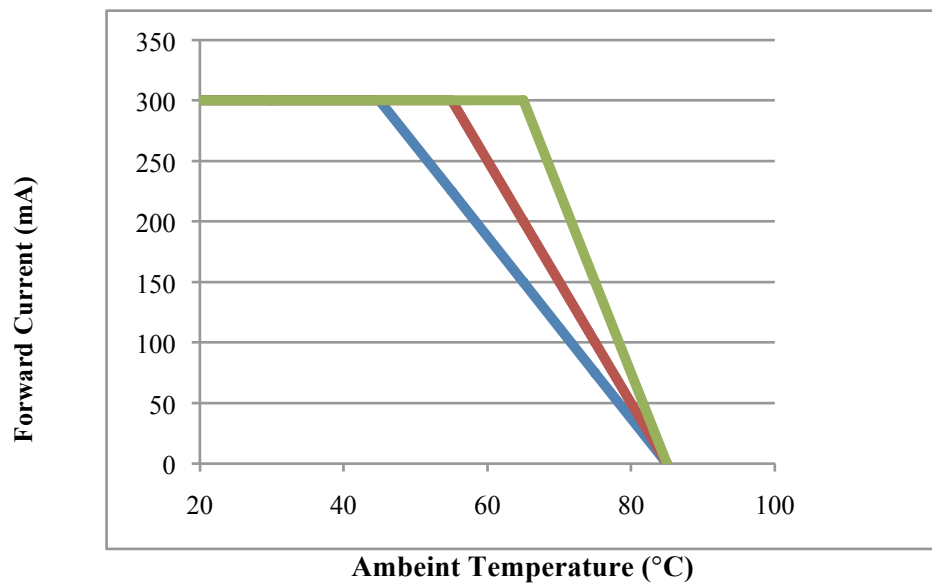

IJFCOB19A Data Sheet



CCT – BIN FOR WARM WHITE LIGHT

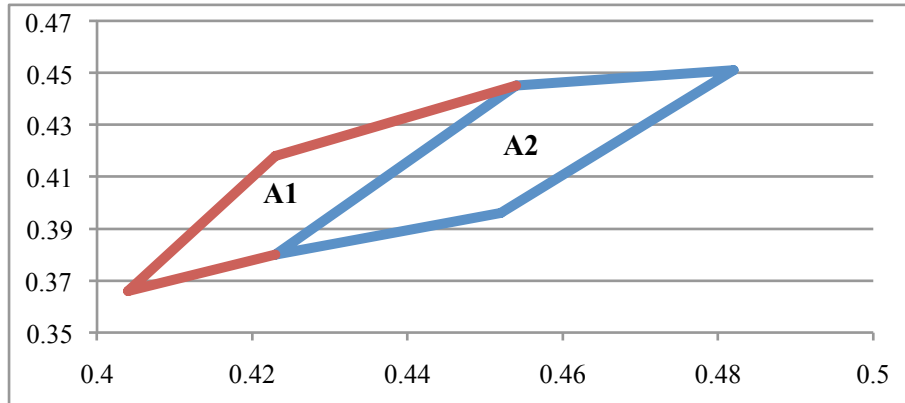

BIN A 1	2700 – 3000K
BIN A 2	3000 – 3300K
BIN A 3	3300 – 3600K
BIN A 4	3600 – 3900K

CCT – BIN FOR NATURAL WHITE

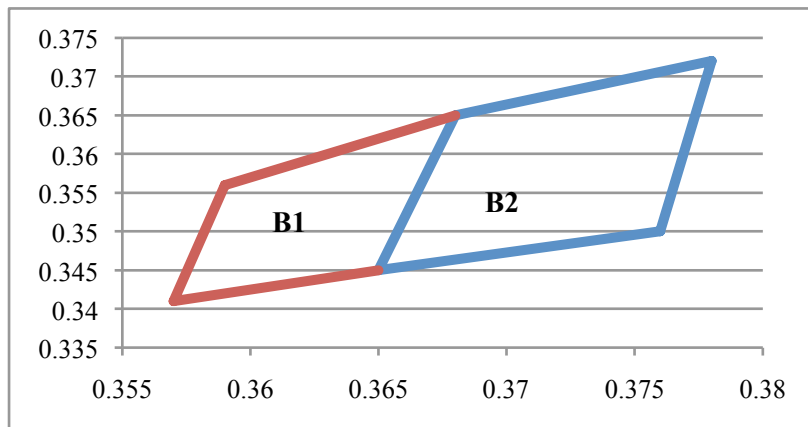

BIN B 1	3900 – 4200K
BIN B 2	4200 – 4500K
BIN B 3	4500 – 4800K
BIN B 4	4800 – 5300K
BIN B 5	5300 – 5800K

IJFCOB19A Data Sheet



CCT – BIN FOR COOL WHITE

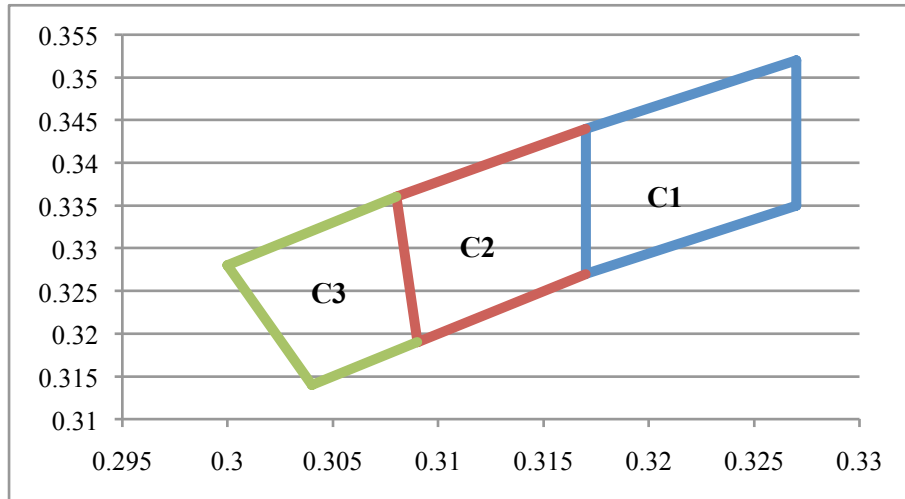

BIN C 1	5800 – 6200K
BIN C 2	6200 – 6600K
BIN C 3	6600 – 7000K
BIN C 4	7000 – 7500K

IJFCOB19A Data Sheet



Package Dimension

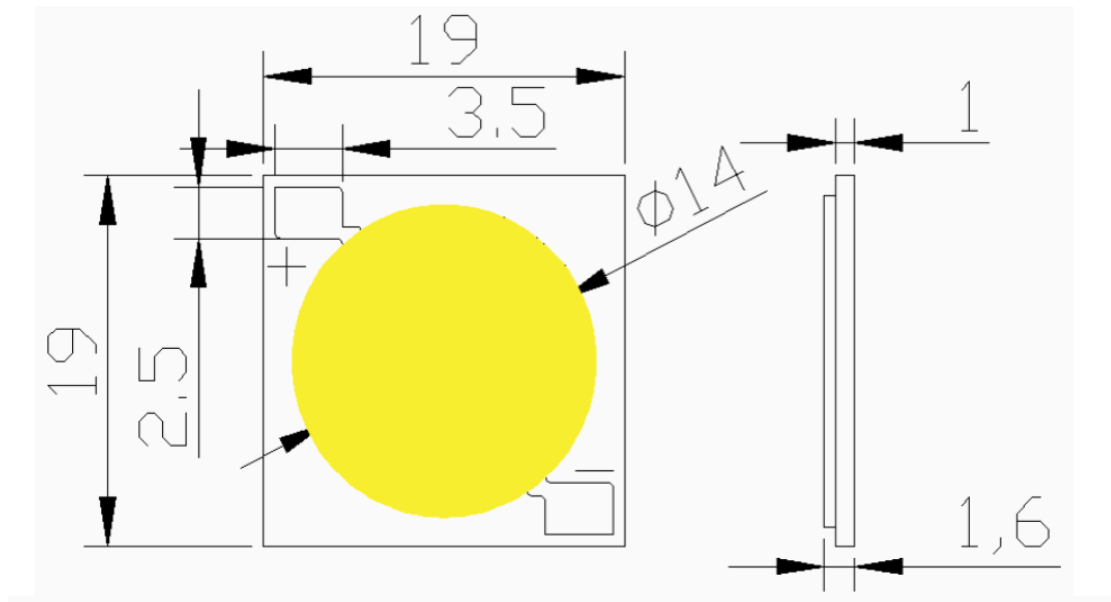

Note:

Tolerance unless mentioned is ± 0.15 mm ; Unit = mm

IJFCOB19A Data Sheet



Notes for Hand Soldering

- Hand Soldering Parameters - 300°C for not more than 3 seconds
- Hand Soldering shouldn't be done more than once.
- Avoid using sharp objects for compressing LEDs
- Use of anti-static apparels while operating on LED Chips is recommended

Storage

Before opening vacuum packing

- LEDs can be stored for one year under temperature and humidity not exceeding 30°C and 60% RH.

After opening vacuum packing

- The LED's floor life is 168 Hrs under 30°C or less and 60% RH or less. If unused LEDs remain, it should be stored in moisture proof packages.